

Potrzebne dodatkowo
przy montażu

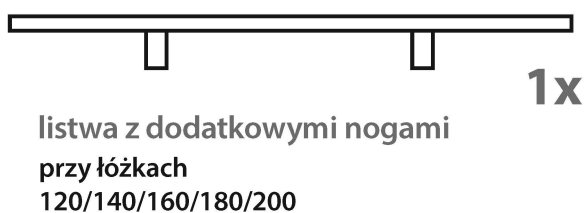

Elementy łóżka

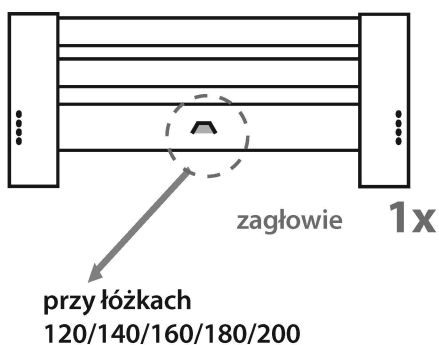

Elementy łączące

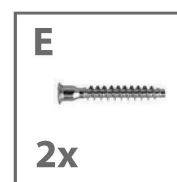
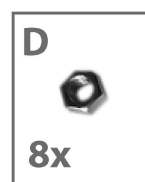
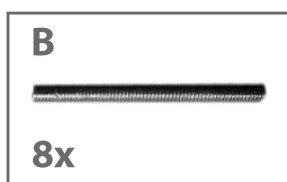
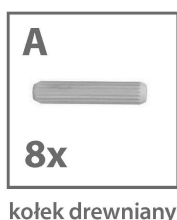

Podczas skręcania łóżka zachowujemy najwyższą staranność, a wszystkie śruby dokręcamy z wyczuciem do momentu kiedy zaczynają stwarzać wyczuwalny opór.

1

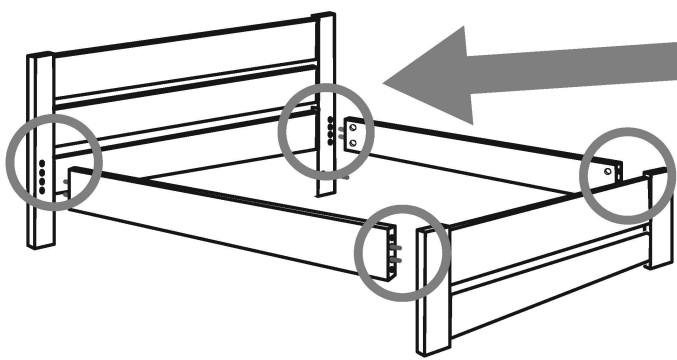
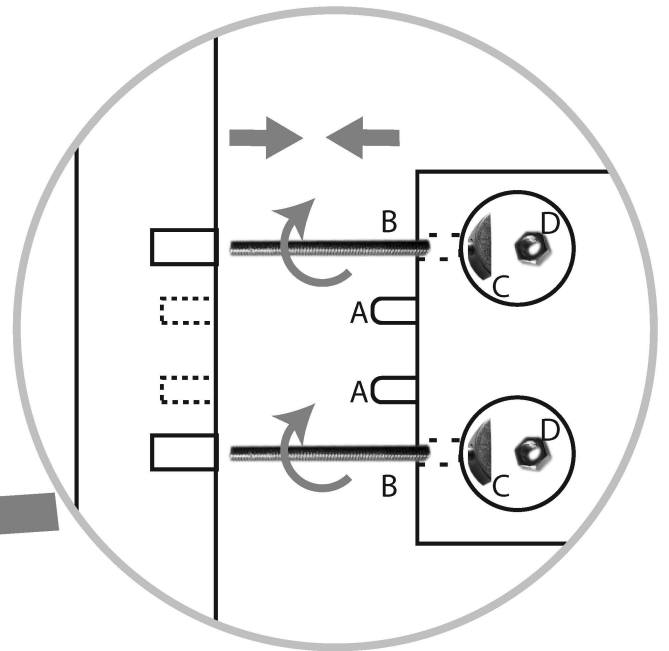

2

przy łózkach
120/140/160/180/200

