

# KALIPSO

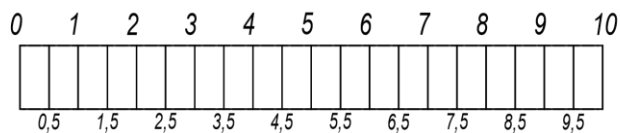

**Bez pojemnika**

e - 032 (x2)

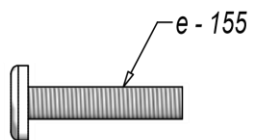
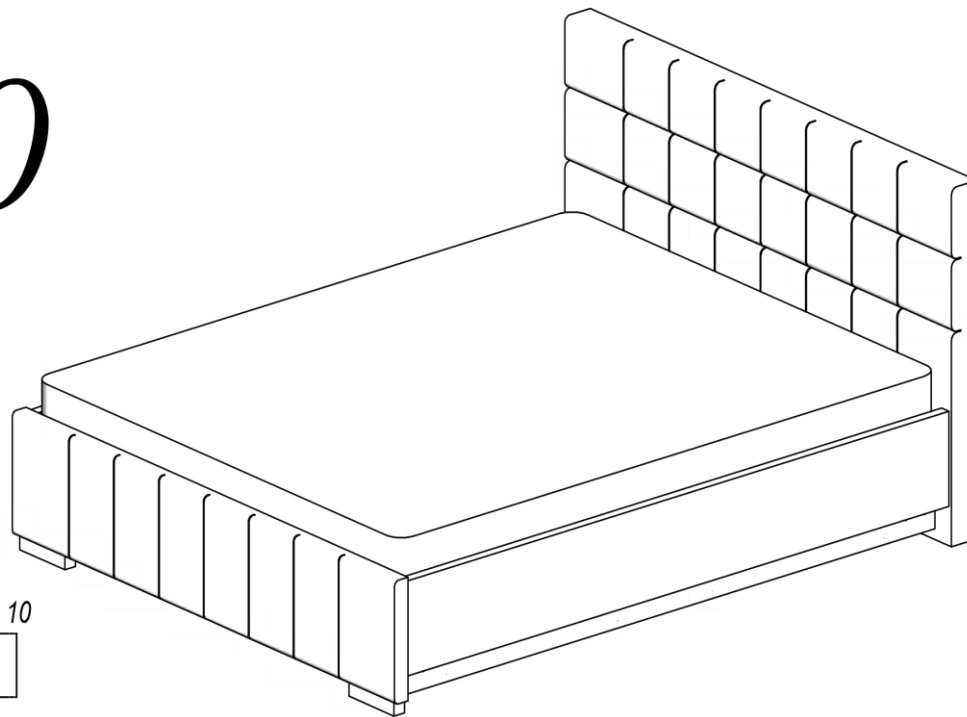
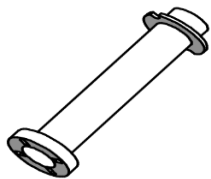

e - 153 (x8)

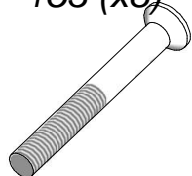

L - 58

e - 133 (x8)

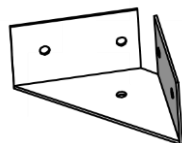

e - 135 (x16)

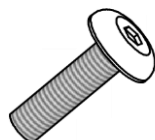

M8x20

e - 124

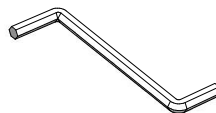

e - 128 (x4)

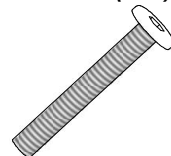

M6x50

e - 150

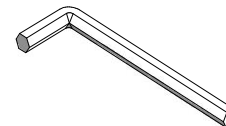

"4"

e - 155 (x16)

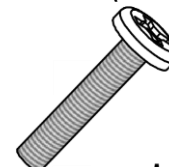

M8x30

e - 055 (x2)

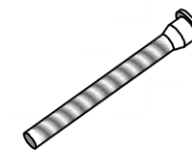

"6"

7x50

KA - 100 - 099

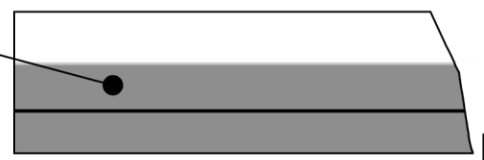

KA - 100 - 099

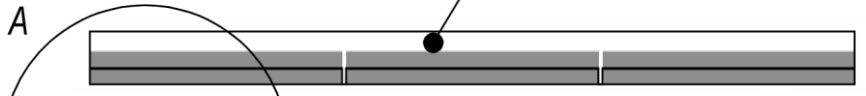

e - 133

e - 135

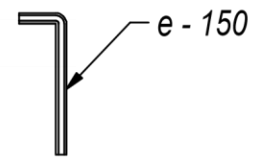
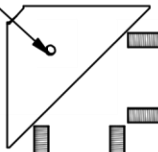
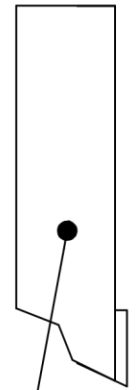

e - 155

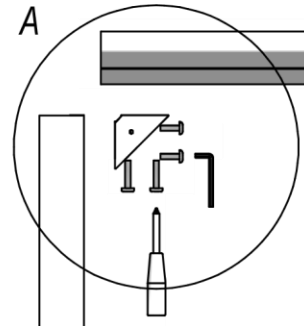
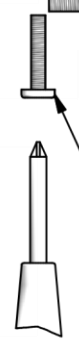

KA - 100 - 002

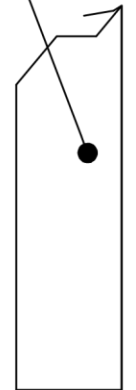

e - 155

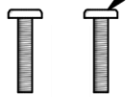

e - 135

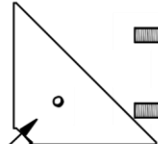

KA - 100 - 002



KA - 100 - 001

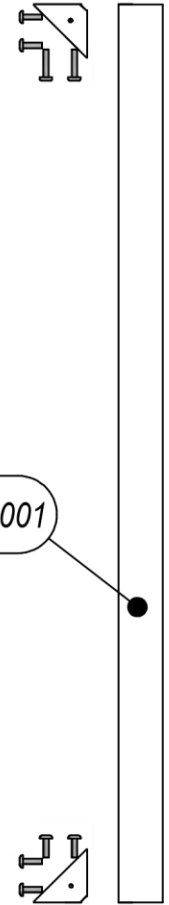

e - 133

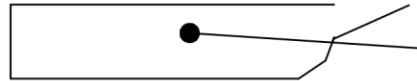

KA - 100 - 098

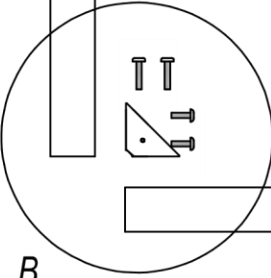

KA - 100 - 098

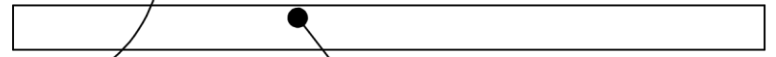

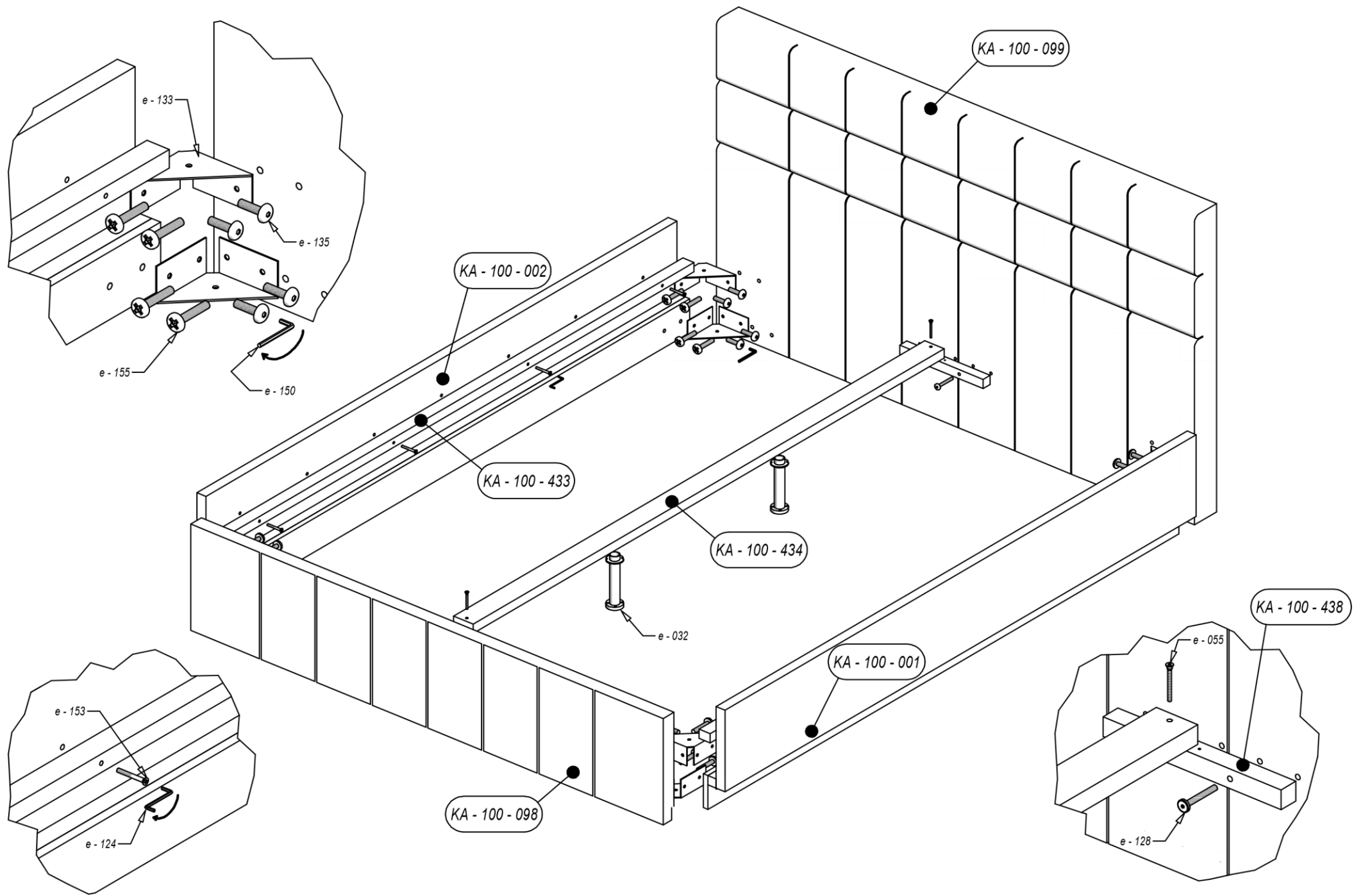

# KALIPSO

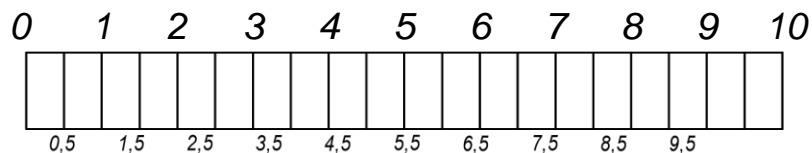
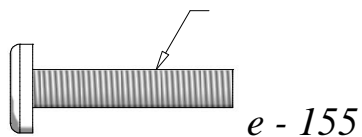
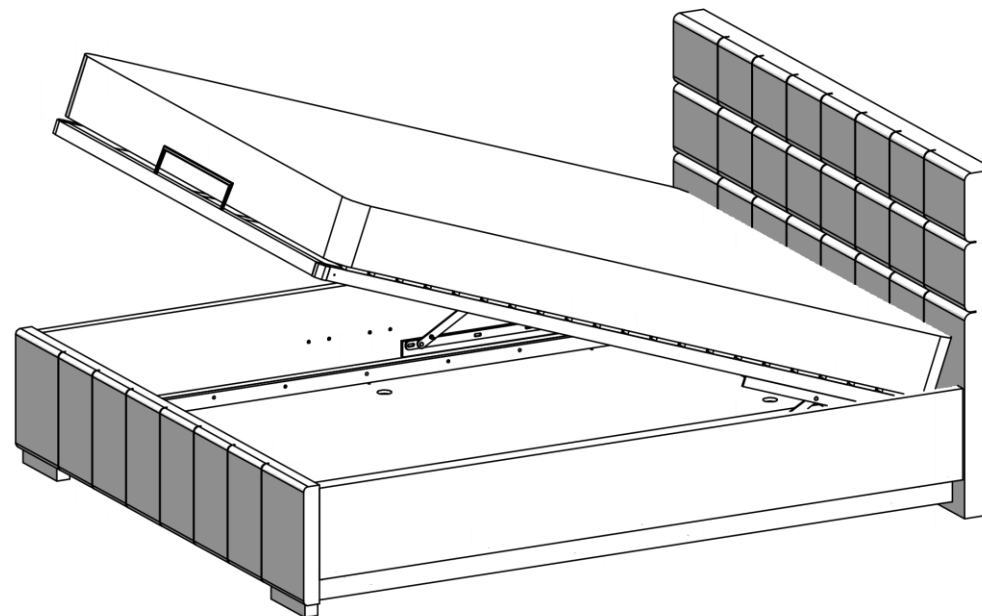

<i>e - 078 (x kpl)</i> 	<i>e - 133 (x8)</i> 	<i>e - 124</i> 	<i>e - 126 (x14)</i> 	<i>e - 156 (x2)</i> 	<i>e - 213 (x4)</i> 	<i>e - 081 (x12)</i> 
<i>e - 139 (x8)</i> 	<i>e - 112 (x4)</i> 	<i>e - 128 (x8)</i> 	<i>e - 082 (x12)</i> 	<i>e - 213 (x16)</i> 	<i>e - 155 (x16)</i> 	<i>e - 079 (x2)</i> 

**Z Pojemnikiem**

KA - 100 - 099

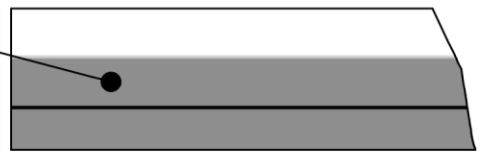

KA - 100 - 099

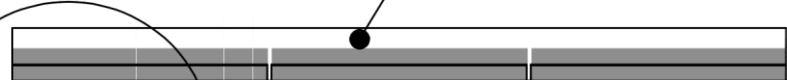

e - 133

e - 213

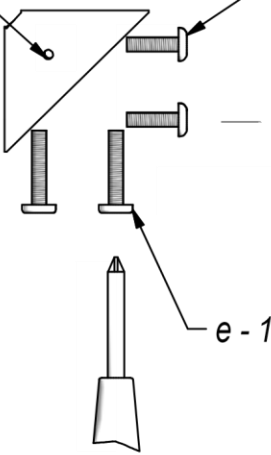
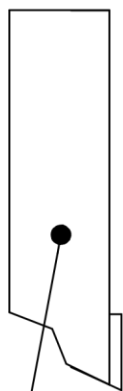
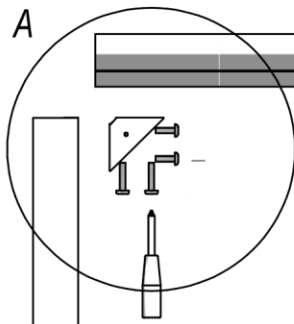

e - 155

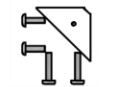

KA - 100 - 002

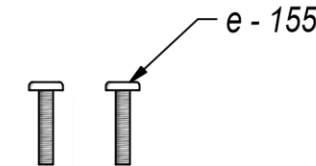
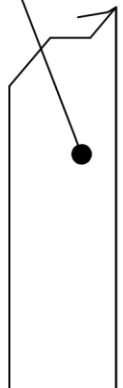

e - 155

e - 213

KA - 100 - 001



KA - 100 - 002

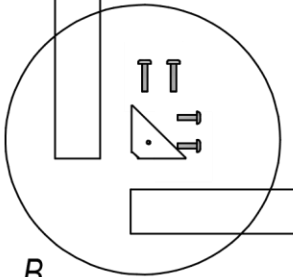

e - 133



KA - 100 - 098

KA - 100 - 098



