

# APOLLO

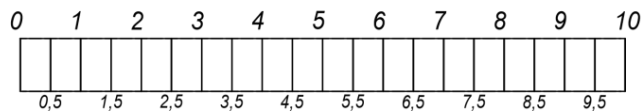

e - 032 (x2)

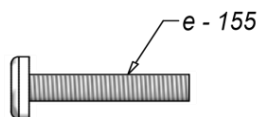
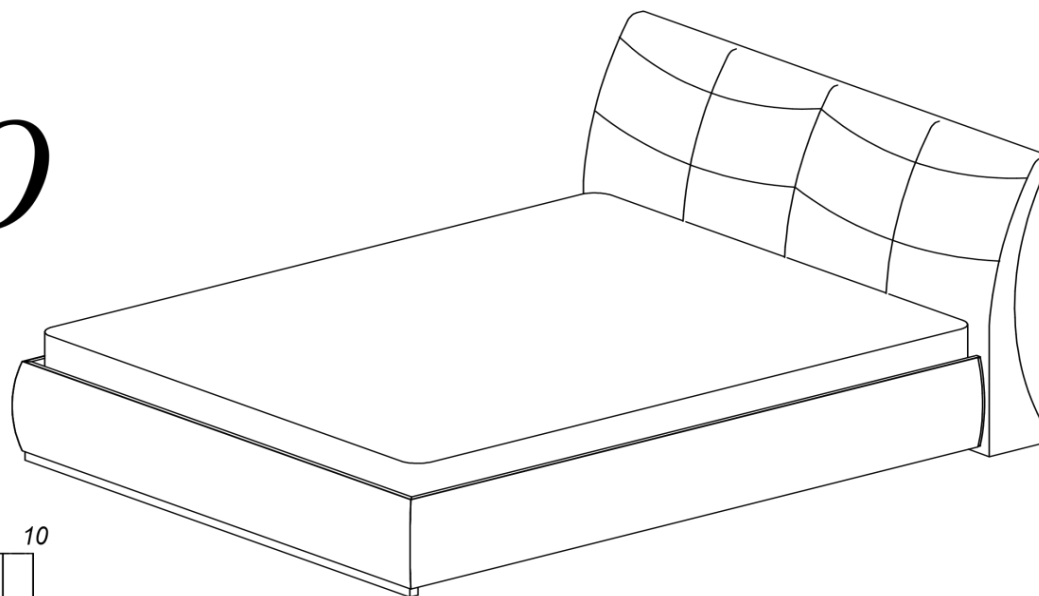
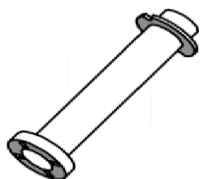

e - 133 (x8)

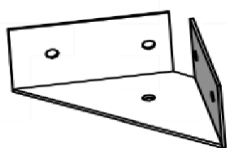

e - 124



e - 150



e - 055 (x2)

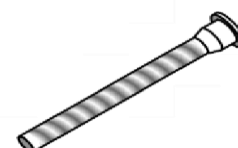

"4"

"6"

7x50

e - 153 (x8)

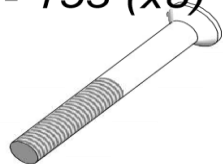

e - 135 (x16)

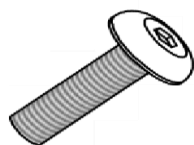

L - 5

M8x20

e - 128 (x4)

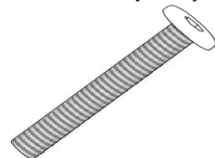

M6x5

e - 155 (x16)

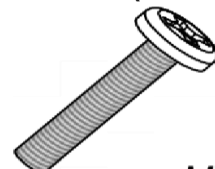

M8x30

**Bez pojemnika**

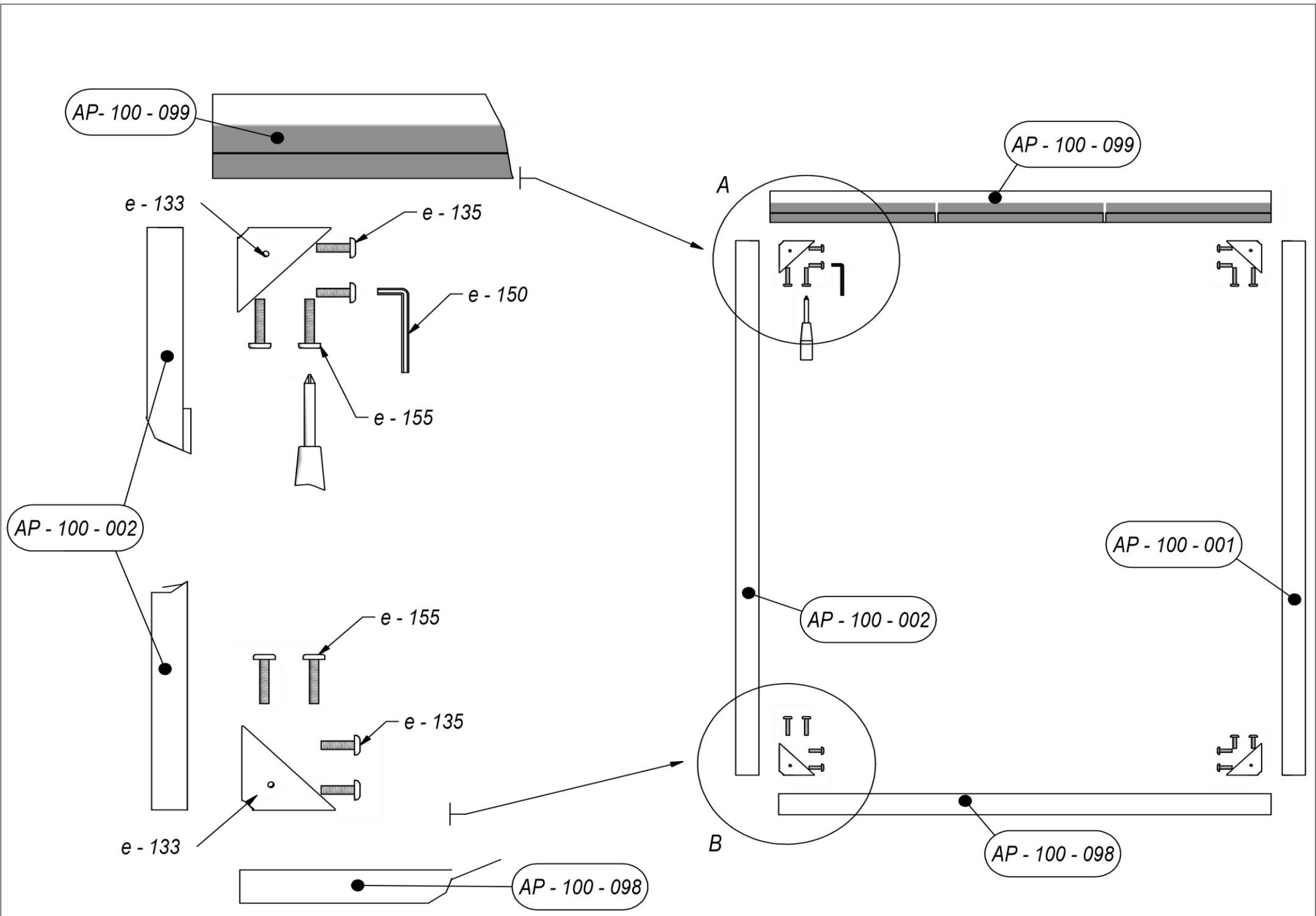

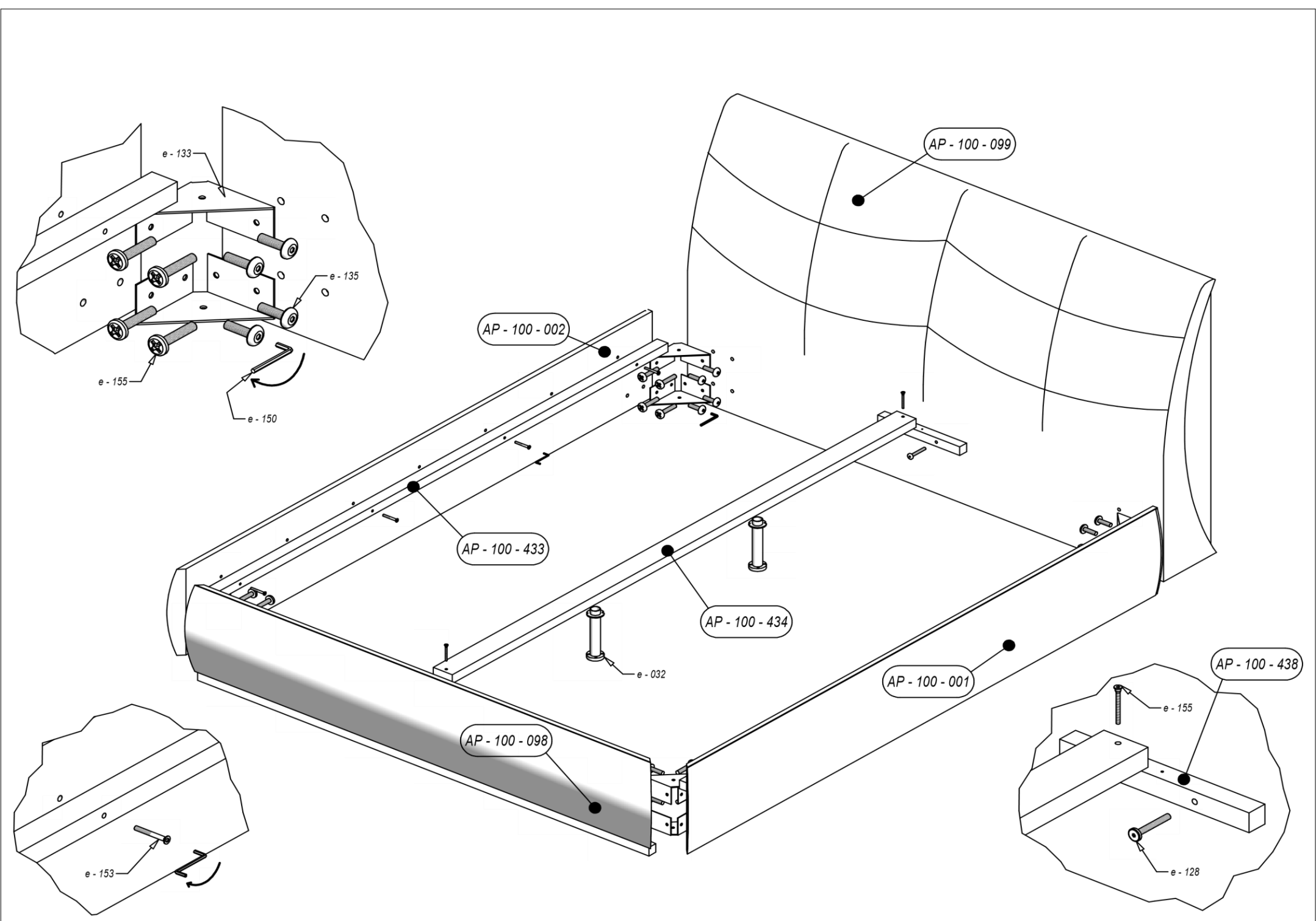

AP - 100 - 099

AP - 100 - 002

AP - 100 - 433

AP - 100 - 434

AP - 100 - 001

AP - 100 - 098

AP - 100 - 438

e - 133

e - 135

e - 155

e - 150

e - 032

e - 153

e - 155

e - 128

# APOLLO

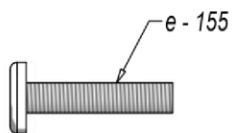
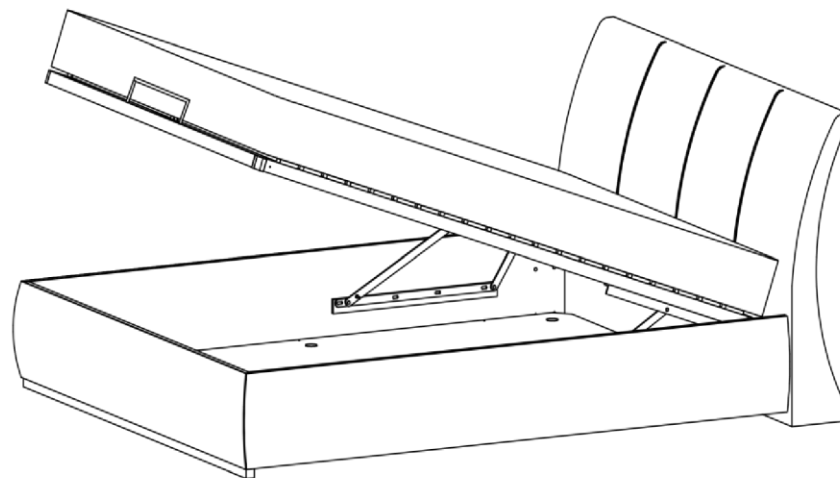

e - 078 (x kpl)

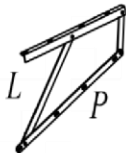

e - 133 (x8)

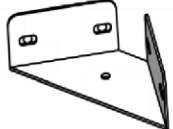

e - 124



e - 079 (x2)



e - 156 (x2)



e - 213 (x4)



e - 081 (x12)



n8

e - 139 (x8)



M6x20 e - 112 (x4)



e - 128 (x8)

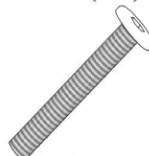

M6x5

e - 082 (x12)

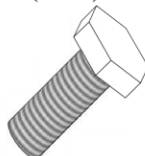

M8x20 e - 212 (x16)



e - 155 (x16)



M8x30

e - 126 (x14)



4x20

5x30

M8x25

**Z pojemnikiem**

